



Measurement for Cooperative Network Defense: DEMONS and BlockMon

Brian Trammell

Communication Systems Group, ETH Zürich

Flocon 2012, January 11, Austin, Texas USA

The problem

- The attack landscape has become more *complex* and *cooperative*.
 - Botnets, XSS, APT, *(scary_buzzword_ary++)
- Network defense remains largely isolated.
 - Siloed within single administrative domains
- → Tools and processes for defense must become more cooperative than (implicit) processes for attack.

Centralization of Traffic Data

- Passive measurement collects enormous amounts of data.
 - "Congratulations, you just pointed a ten gig firehose at yourself"
- (Almost) all of it is simultaneously
 - quite sensitive,
 - and completely uninteresting.

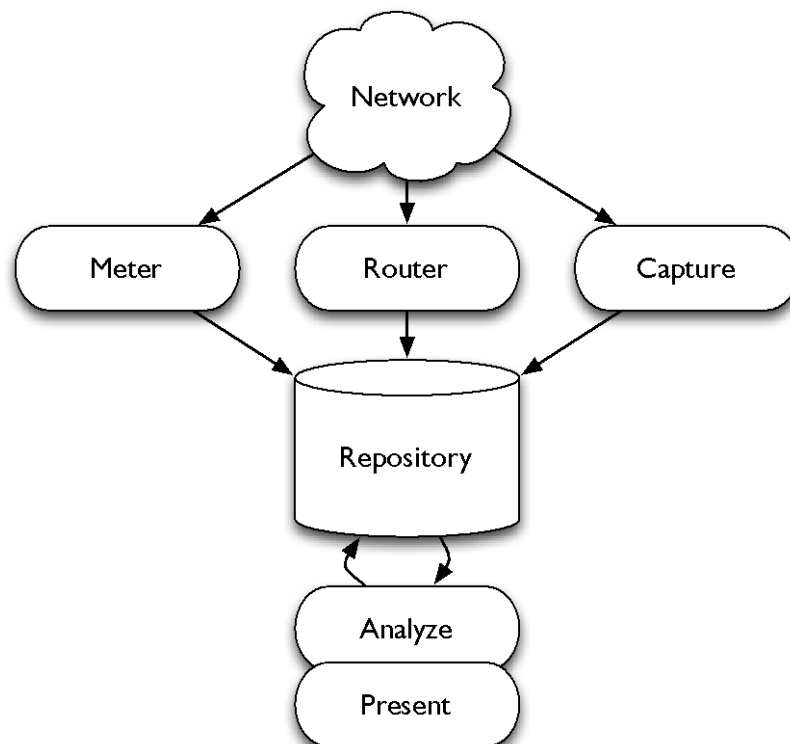

Sharing Traffic Data

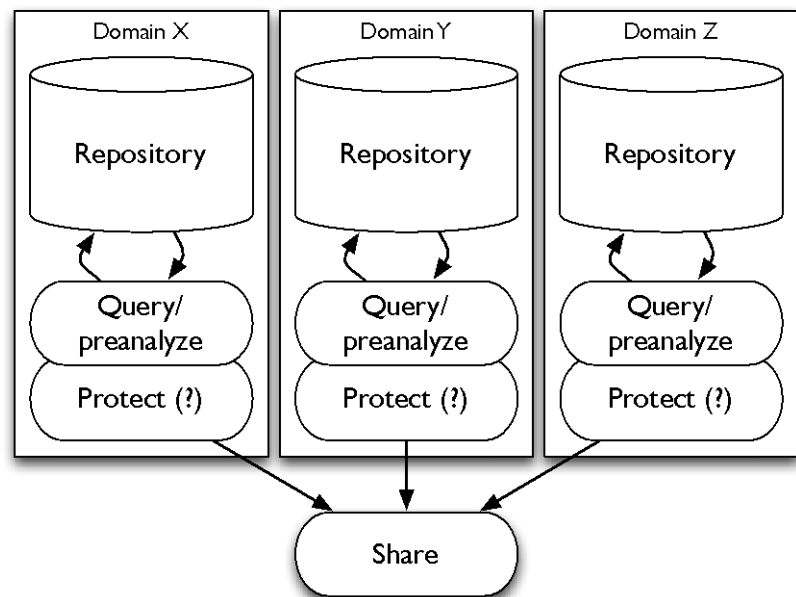

- Cooperative incident handling requires sharing of data across domains.
- *Data sharing is fraught with peril.*
 - Legal, regulatory, and business-sensitivity restrictions on data protection and disclosure
 - Anonymization not a solution to the problem
 - Pattern injection on Internet traffic practically undetectable [1]; partial offline reversal of anonymization possible.

[1] Burkhart et al., "The Role of Network Trace Anonymization Under Attack", ACM Computer Communications Review, vol. 40 no. 1, January 2010



Cooperative Network Defense

DEMONS

The DEMONS Approach

Centralized

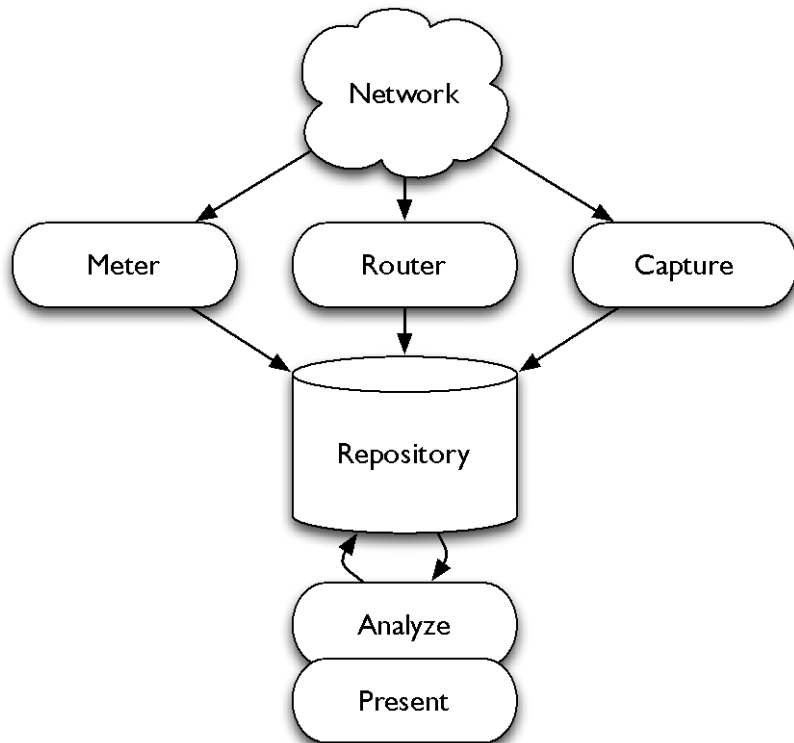

DEMONS

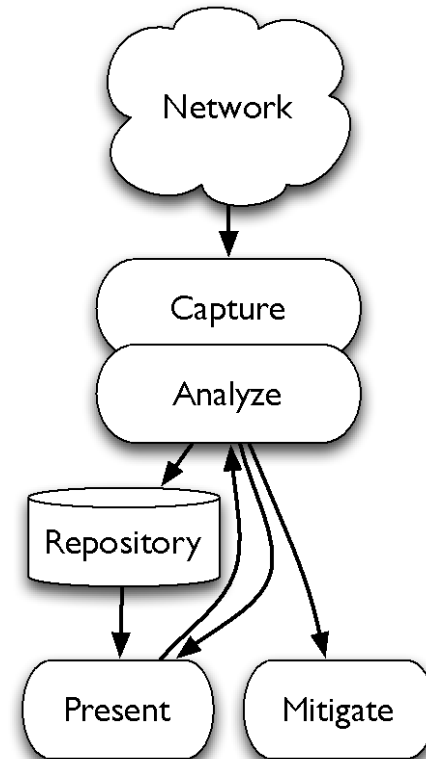

DEMONS: The Project

- EC-funded, FP7 ICT IP, Sep 2010–Mar 2013
- Goal: ***Enable cooperative detection and mitigation of incidents effecting network stability and security.***
- Consortium of 13 in 9 countries, includes three network operators (Telefónica, FT, TP)

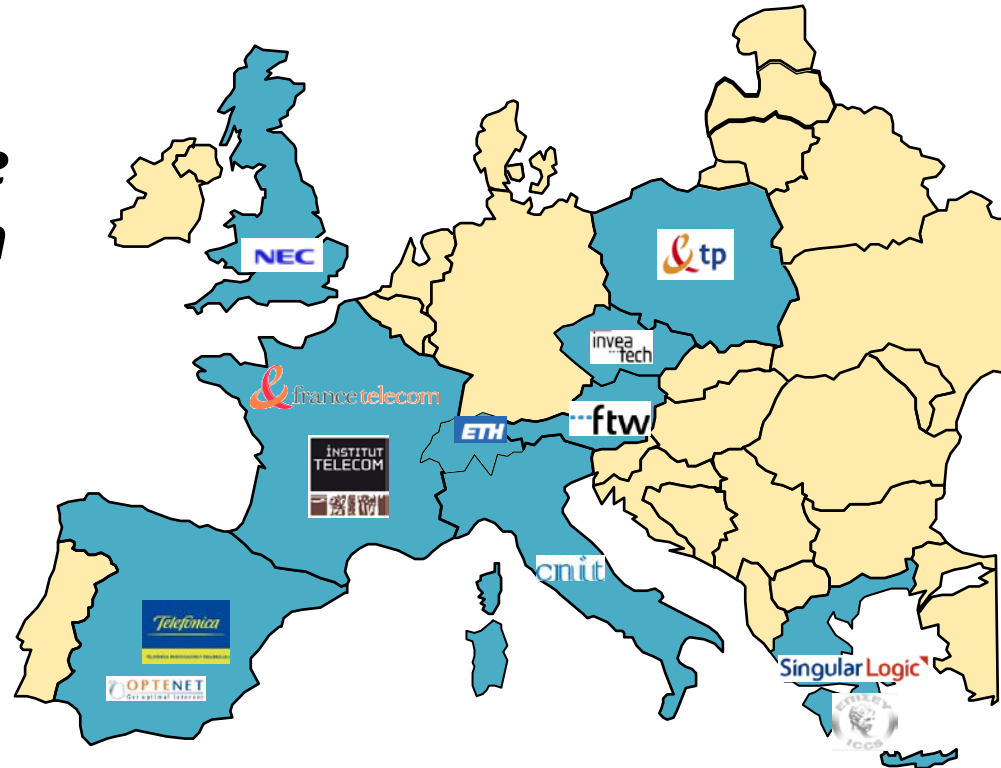

The DEMONS approach: decentralization

- *Move processing to the edge*
- Support iterative analysis on live traffic using programmable edge devices.
- Emphasize stream processing over retrospective analysis, use existing processes for forensics.
- Data reduction on the measurement device improves scalability and reduces sensitivity of collected data.
- Integration with existing mitigation processes.

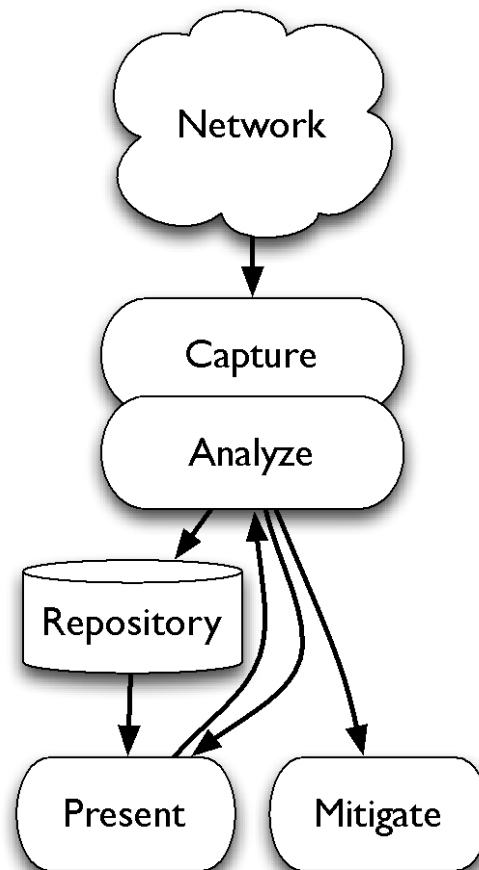

The DEMONS approach: sharing

- *Share analysis, not data*
- Analyses built by composition of well-defined processing modules
- Inspection of intermediate results before export
- Application of secure multiparty computation schemes, where appropriate
- Realism about technical limitations of data protection

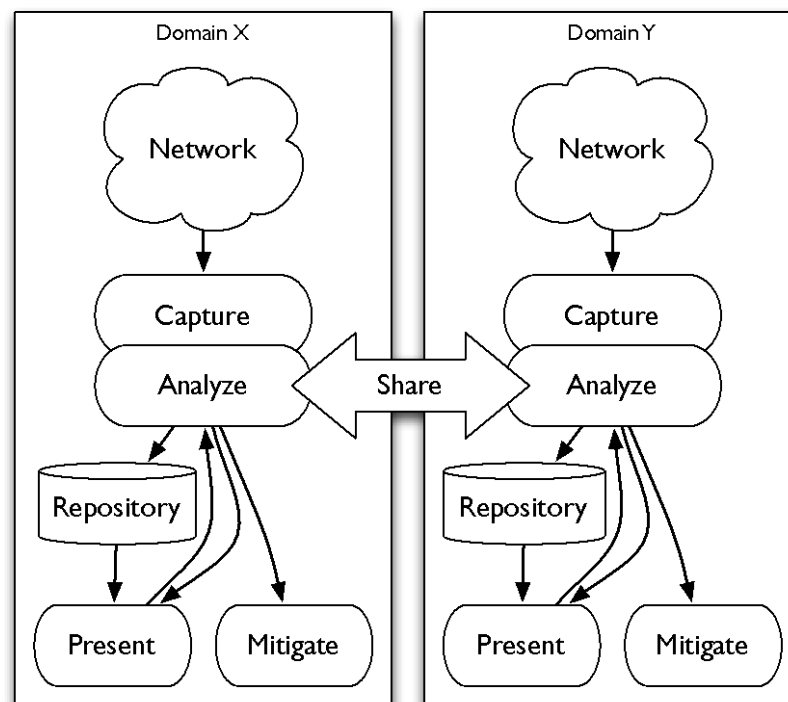

DEMONS Components and Interfaces

- Measurement layer nodes provide capture and analysis.
- Interdomain exchange point (IXP) provides "sharing" interfaces to external domains.
- Mitigation control point (MCP) provides interface to existing processes.
 - Additional research within the project WRT policy-driven pseudo-automatic mitigation, MPLS-based quarantining

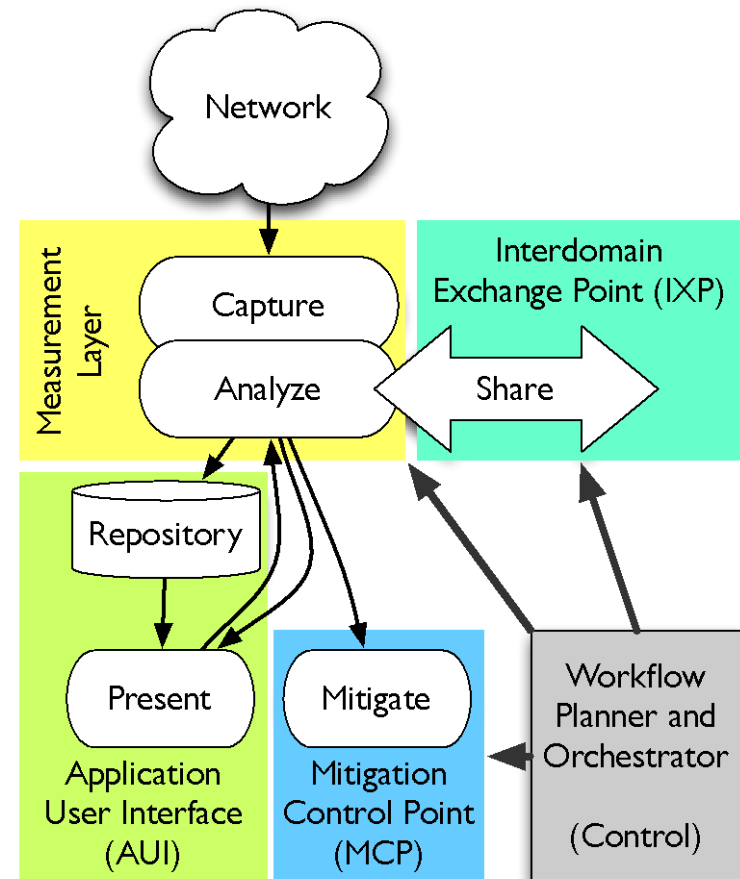



Composable Network Measurement

BLOCKMON

Introducing BlockMon: Goals

- Composable measurement using small blocks
 - Increases parallelizability, measurement performance on multicore hardware
 - Code reuse for measurement development
- Platform for understanding composable measurement application development
- Enable code and analysis interchange in the form of compositions of modules from a standard, trusted base

BlockMon

- Compositions of *blocks* exchange *messages* connected via *gates*.
- Blocks are implemented in C++, framework and scheduling in C++, focus on performance
- XML-based composition schema
- Python-based CLI and JSON-RPC daemon

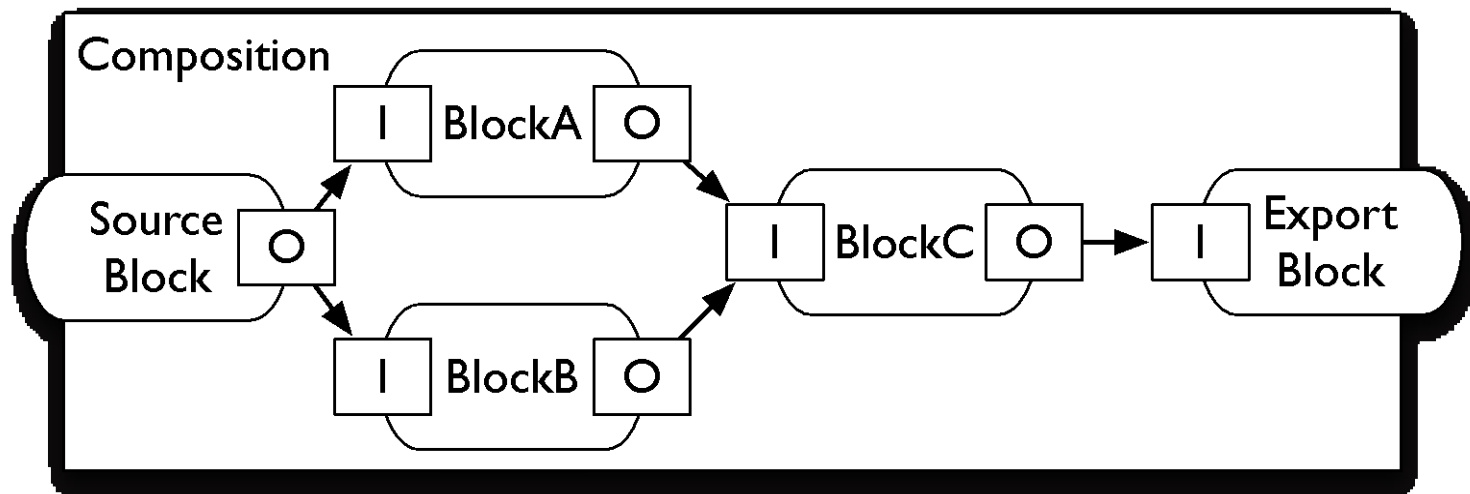

BlockMon: out-of-box experience

- Core messages, bridged to IPFIX
 - Packet, with lazy parsing & cache-aware allocation
 - Flow, allows use of BlockMon as a streaming flow analysis tool
 - Message base class allows *tagging* for adding features or annotations to a message in flight
- Source, exporter, simple counter blocks
- Current work on taxonomy of blocks
 - filters, metrics, features, correlations, feedback

BlockMon: How fast is fast?

Synthetic traffic (10Gbps)

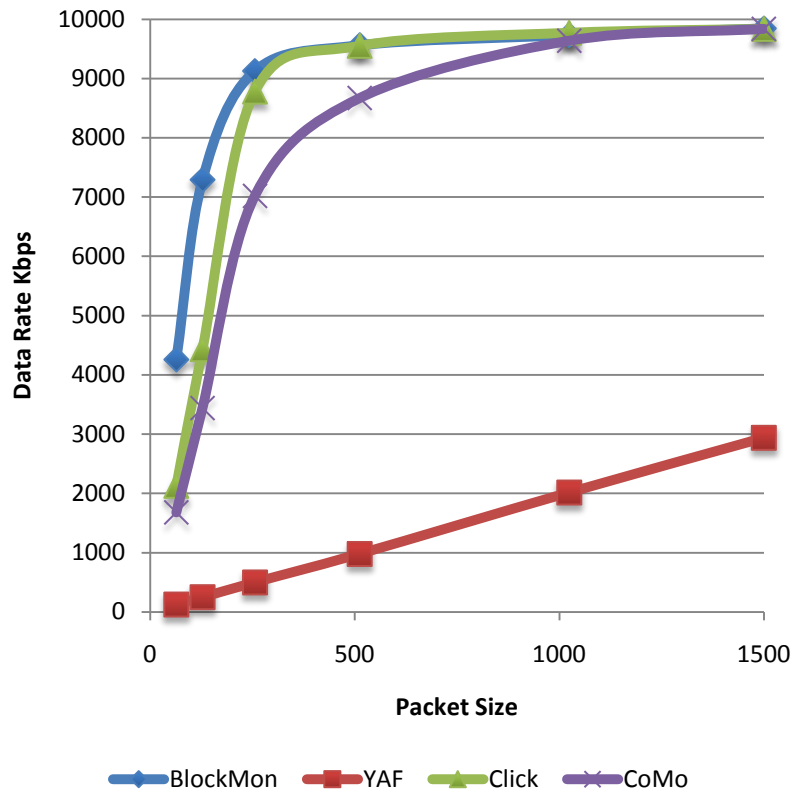

Trace replay (6Gbps peak)

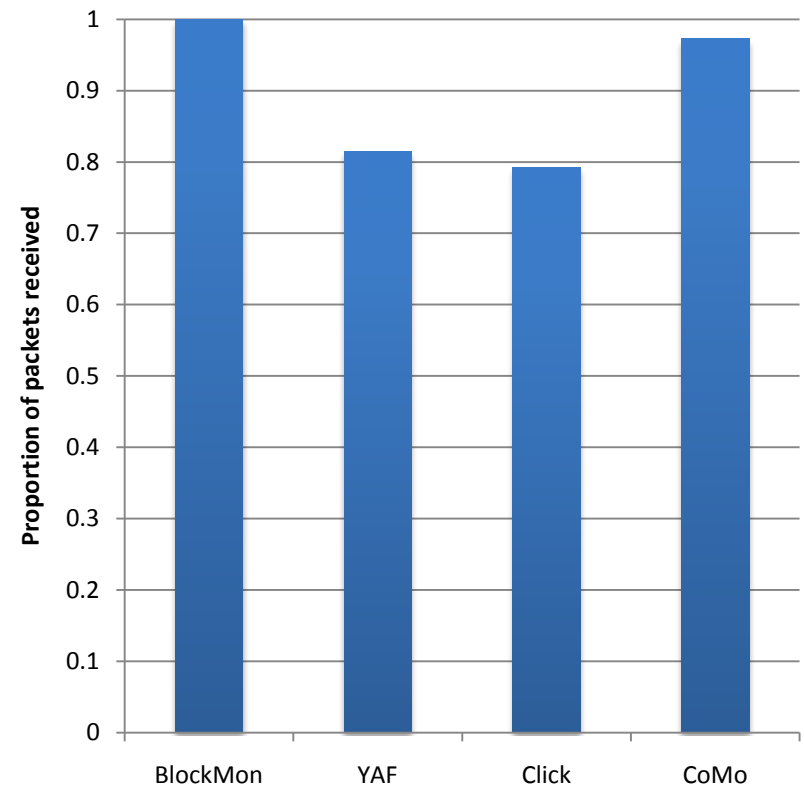

Case Study: VoIPSTREAM Abuse Detection

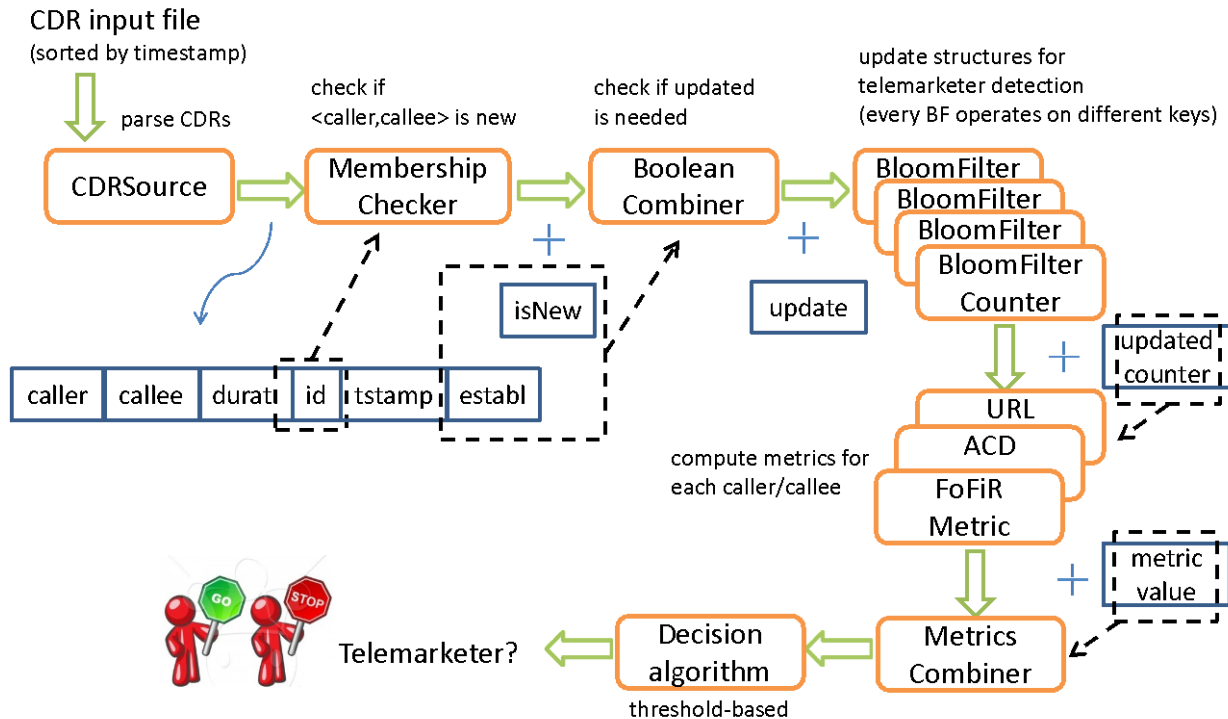

- Every Block is active, processes a CDRMsg (composition of PairMsg and Tags), and appends its own tag to it.
- BloomFilterCounters blocks are configured to work on a time-window base (i.e., 6hour long).

Play Along at Home

- BlockMon to be released as open-source software, BSD licensed.
- Development of the core presently *very active*
- Find me this week or e-mail `<trammell@tik.ee.ethz.ch>` if you're interested.

Conclusions

- Current attacks require cooperative defense.
- Data sharing is fraught with peril.
- Move processing to the edge.
- Share analysis, not data.
- Composable measurement makes it possible.

Acknowledgments

- FP7-DEMONS project
 - funded by the European Commission
- BlockMon Team
 - NEC Laboratories Europe
 - CNIT (Consorzio Nazionale Interuniversitario per le Telecomunicazioni)