



Quantifying the Value of Architecting within Agile Software Development via Technical Debt Analysis

Software Engineering Institute
Carnegie Mellon University
Pittsburgh, PA 15213

Nanette Brown, Robert L. Nord, Ipek Ozkaya (SEI)
Philippe Kruchten (University of British Columbia)

May 23, 2011



Guiding Scenario

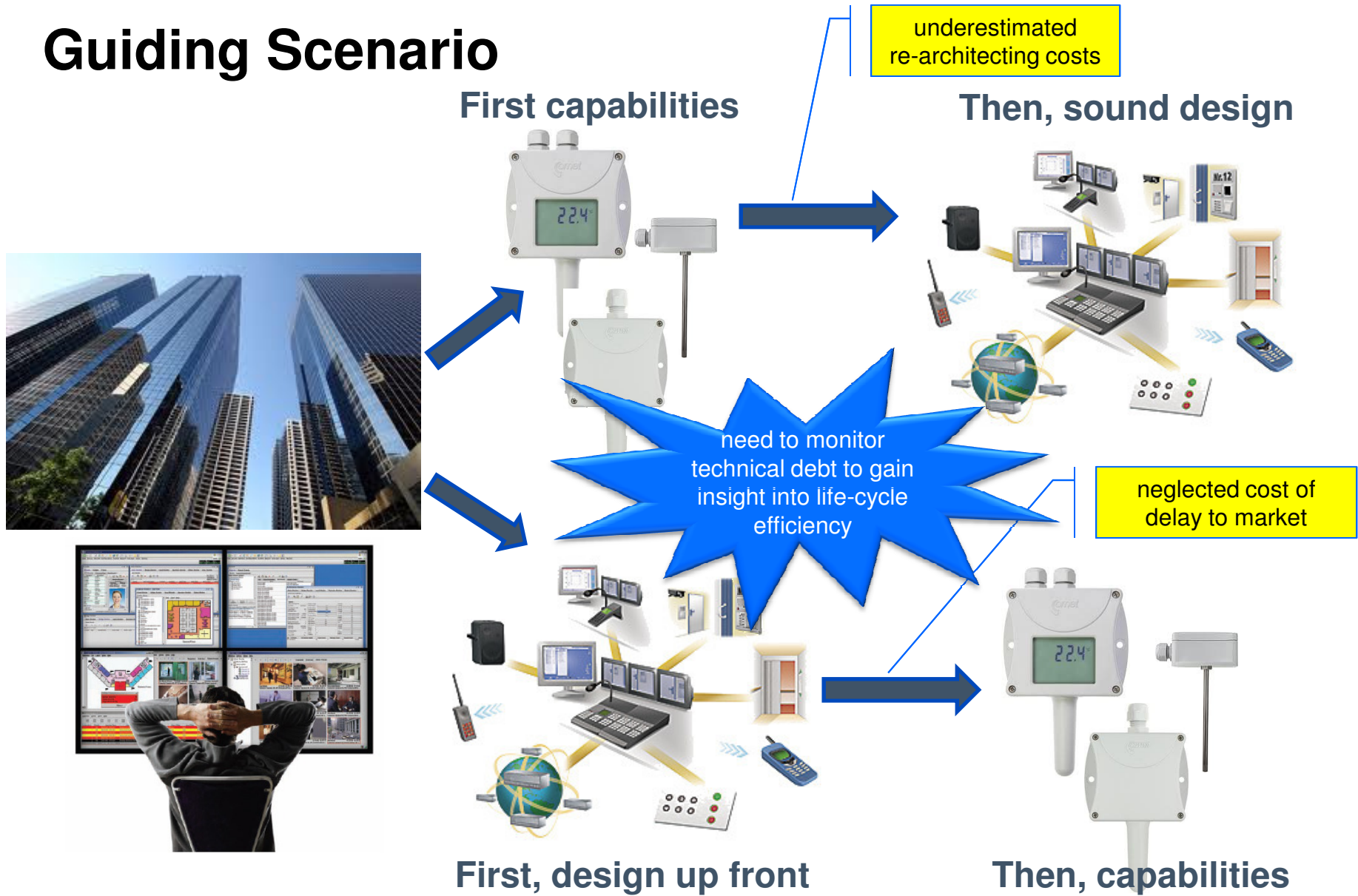

Future Directions – SEI Research

Focus on Value

Velocity

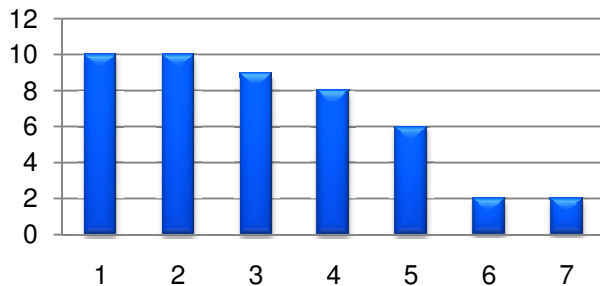

Manage architectural dependencies with dependency structure matrices

\$root						
03 Alarm Engine	1	20%				
06 Client Updates	2		20%			
07 Rule Processor	3	1		20%		
09 User Sessions Manager	4		1	1	20%	
14 Publish-Subscribe Bus	5	1		1	1	20%

Focus on Integrated ROI

Velocity

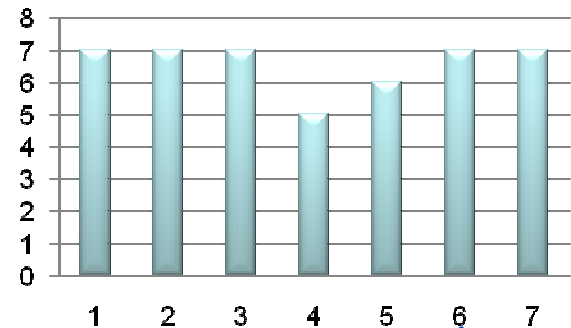

Focus on Cost

Velocity

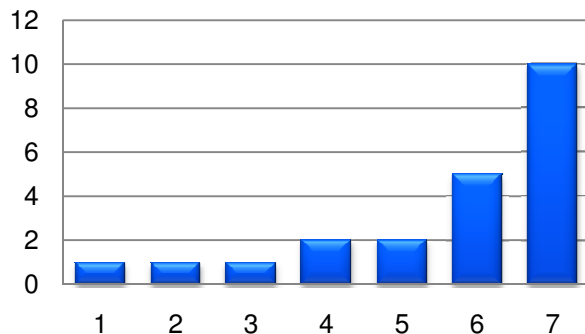

Use propagation cost as a metric to monitor and focus development tasks

Ability to adjust course with empirical basis



Analysis and Management of Architectural Dependencies in Iterative Release Planning

Modeling Dependencies

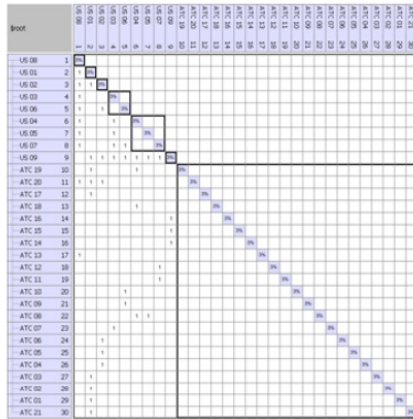

DSM - customer requirements

root	1	2	3	4	5	6	7	8	9	10	11	12	13	14											
01 Alarm Notification	1	7%																							
02 L&R Engine		2	7%																						
03 Alarm Engine		3	1	7%	1																				
04 Alarm Manager		4	1	1	7%																				
05 Logon					5	7%																			
06 Client Updates							6	7%																	
07 Rule Processor									7	7%															
08 Adapter Manager											8	7%													
09 User Sessions Manager													9	7%											
10 Data Access															10	7%									
11 Cache																	11	7%							
12 FSS Adapter																			12	7%					
13 Data Persistence																					13	7%			
14 Publish-Subscribe Bus																							14	7%	

DSM - architectural elements

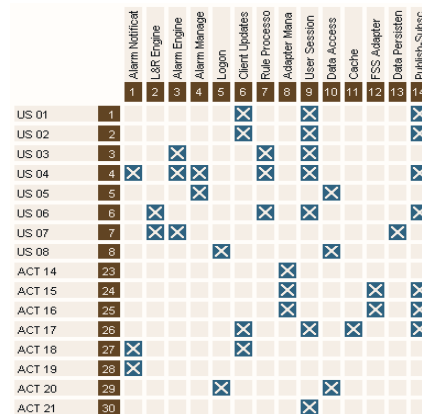

DMM - requirements to elements

Metrics

$$Tc_n = Ic_n + Rc_n$$

$$Pc = \frac{\sum_{i=0}^n M_i}{n^2}$$

Economic Models

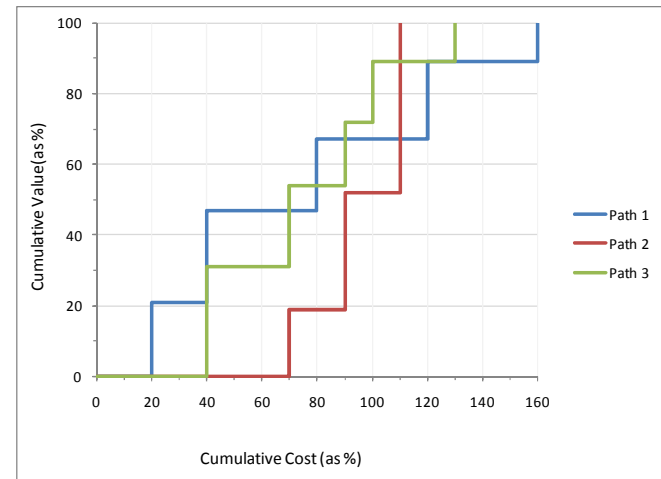

Value of Capabilities Delivered over Total Effort

Total cost as a function of implementation and rework cost

Propagation cost



Technical Measures

Rework cost, Rc_n , for release n is computed as follows:

- Compute the rework cost associated with each new architectural element AE_k as the sum of the rework cost for each pre-existing AE_j

$$Rc(AE_j) = \#dependencies(AE_j, AE_k) * Ic(AE_j) * Pc(n-1).$$

- Sum the rework cost for all new architectural elements AE_k

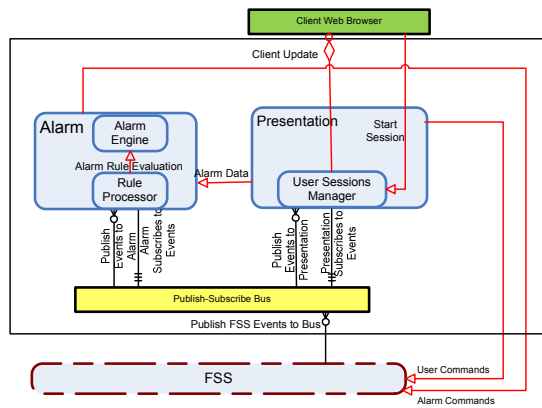

\$root		←	→	ω	Δ	∩
03 Alarm Engine	1	20%				
06 Client Updates	2		20%			
07 Rule Processor	3	1		20%		
09 User Sessions Manager	4		1	1	20%	
14 Publish-Subscribe Bus	5	1		1	1	20%

Release n-1

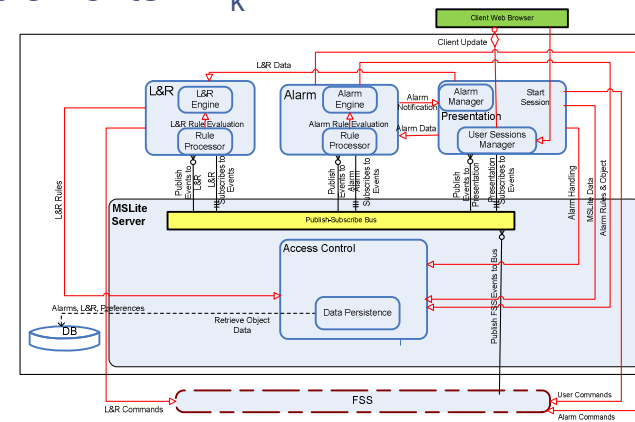

\$root		←	→	ω	Δ	∩	∪	∩	∪
01 Alarm Notification	1	11%							
02 L&R Engine	2		11%						
03 Alarm Engine	3	1		11%	1				
04 Alarm Manager	4	1		1	11%				
06 Client Updates	5					11%			
07 Rule Processor	6		1	1			11%		
09 User Sessions Manager	7				1	1	1	11%	
13 Data Persistence	8		1	1				1	11%
14 Publish-Subscribe Bus	9		1	1			1	1	11%

Release n



Discussion Questions

The rework algorithm rework is directional in nature and represents an initial effort to formalize the impact of architectural dependencies.

- What are the appropriate proxies of complexity that affect the cost of change?

Rework cost is interpreted as a relative value, used to compare alternative paths and to provide insight into the improvement or degradation of architectural quality across releases within a given path.

- How do we incorporate uncertainty and the forecast of future rework in the model?

The ability to quantify degrading architecture quality and the potential for future rework cost during iterative release planning as each release is being planned is a key aspect of managing strategic technical debt.

- How do we characterize the economics of architectural violations across a long-term roadmap, rather than enforce compliance for each release?



Contact Information

RTSS Program

Linda Northrop
RTSS Program Director
Software Engineering Institute
Pittsburgh, PA 15213
lmn@sei.cmu.edu

Agile Architecting

Nanette Brown, Robert Nord, Ipek Ozkaya
Software Engineering Institute
nb, rn, ozkaya @sei.cmu.edu
Philippe Kruchten
University of British Columbia
pbk@ece.ubc.ca

Business Development

Austin Montgomery amontgom@sei.cmu.edu
SEI website at www.sei.cmu.edu/architecture

Additional Information

Nanette Brown, Robert Nord, Ipek Ozkaya, Manuel Pais. Analysis and Management of Architectural Dependencies in Iterative Release Planning. In: *Proceedings of the Working IEEE/IFIP Conference on Software Architecture (WICSA) 2011*.



NO WARRANTY

THIS CARNEGIE MELLON UNIVERSITY AND SOFTWARE ENGINEERING INSTITUTE MATERIAL IS FURNISHED ON AN "AS-IS" BASIS. CARNEGIE MELLON UNIVERSITY MAKES NO WARRANTIES OF ANY KIND, EITHER EXPRESSED OR IMPLIED, AS TO ANY MATTER INCLUDING, BUT NOT LIMITED TO, WARRANTY OF FITNESS FOR PURPOSE OR MERCHANTABILITY, EXCLUSIVITY, OR RESULTS OBTAINED FROM USE OF THE MATERIAL. CARNEGIE MELLON UNIVERSITY DOES NOT MAKE ANY WARRANTY OF ANY KIND WITH RESPECT TO FREEDOM FROM PATENT, TRADEMARK, OR COPYRIGHT INFRINGEMENT.

Use of any trademarks in this presentation is not intended in any way to infringe on the rights of the trademark holder.

This Presentation may be reproduced in its entirety, without modification, and freely distributed in written or electronic form without requesting formal permission. Permission is required for any other use. Requests for permission should be directed to the Software Engineering Institute at permission@sei.cmu.edu.

This work was created in the performance of Federal Government Contract Number FA8721-05-C-0003 with Carnegie Mellon University for the operation of the Software Engineering Institute, a federally funded research and development center. The Government of the United States has a royalty-free government-purpose license to use, duplicate, or disclose the work, in whole or in part and in any manner, and to have or permit others to do so, for government purposes pursuant to the copyright license under the clause at 252.227-7013.

